

**GEO SAFARI®**

EI-5306  
Ages 8+  
Grades 3+

# Omega Reflector Telescope



Developed in Southern California by Educational Insights.  
© Educational Insights, Inc., Gardena, CA (U.S.A.). All rights reserved. Learning Resources Ltd., King's Lynn, Norfolk (U.K.). Please retain this information.  
Made in China.  
[www.EducationalInsights.com](http://www.EducationalInsights.com)

Fabriqué en Chine. Informations à conserver.  
Made in China. Bitte bewahren Sie unsere  
Adresse für spätere Nachfragen auf.  
Hecho en China. Conservar estos datos.



RISQUE D'ÉTOUFFEMENT. Petites pièces.  
Interdit aux enfants en dessous de 3 ans.  
ERSTICKUNGSGEFAHR. Kleine Teile. Nicht geeignet  
für Kinder unter 3 Jahren.  
PELIGRO. No conveniente para niños menores de 3 años por  
ser susceptible de producir piezas pequeñas que pueden ser ingeridas.



**WARNING:**  
CHOKING HAZARD—Small parts.  
Not for children under three (3) years.

# Table of Contents

- Introduction ..... 2
- Getting Started ..... 2
  - Parts of Your Omega Reflector ..... 2
- Let's Look at Your Omega Reflector ..... 3
- Assembly Diagram ..... 4
- Assembling Your Telescope ..... 5
- The Finder Scope ..... 7
  - Installing Your Finder Scope ..... 7
  - Aligning Your Finder Scope ..... 7
- Using Your Telescope ..... 8
  - Choosing an Eyepiece for Viewing ..... 8
  - Using the Barlow Lens ..... 8
  - Using Your Telescope for Terrestrial Viewing ..... 9
  - Tips for Telescope Use ..... 9
- Frequently Asked Questions ..... 10
- Observing the Night Sky ..... 10
  - Planets ..... 10
  - Stars ..... 10
  - The Moon ..... 11
- Learn More About Astronomy ..... 12
- Caring for Your Telescope ..... 12
  - Storage ..... 12
  - Optics ..... 12
- Warranty ..... 13

**CAUTION:**

Never look directly at the sun, with or without your telescope. Never aim your telescope at the sun, or anywhere near the sun. Instant and irreversible eye damage can occur, including blindness.

Do not let children use the telescope without adult supervision any time the sun is above the horizon.

NOTE: Component colors may vary from those shown in the illustrations.

## Introduction

Your Omega Reflector is a Newtonian reflector telescope. Light enters the open end of the tube and travels down to the opposite end where it strikes a specially curved mirror, known as the primary mirror. The focused image is reflected back up the tube to a small, flat mirror near the open tube end, called the secondary mirror. This secondary mirror reflects the focused image out through the side of the telescope tube to the eyepiece holder where it is enlarged for viewing through the eyepiece. Your telescope will enable you to see many interesting objects in the night sky, from the moon's craters and Saturn's rings to galaxies and nebulae, as well as giving you an up-close view of remarkable things here on earth, from animals to landforms. The information in this guide will help you get the most from your telescope.

## Getting Started

Remove all of the components from the box. Using the list and picture below, identify and inventory each of the parts of your telescope. It is recommended that you keep your telescope box for long-term storage, or should you ever need to return the telescope for service.

### Parts of Your Omega Reflector:

- A. Finder scope with bracket
- B. Accessory tray
- C. 3x Barlow lens
- D. Image erector (erecting eyepiece)
- E. Eyepieces (3)
- F. Yoke (and altazimuth mount)
- G. Tripod support bracket
- H. Tripod leg attachment bolts and wing nuts (3)
- I. Tripod leg adjustment knobs (3)
- J. Micro-adjustment altitude control rod
- K. Optical tube assembly
- L. Tripod legs (3)



2

## Let's Look at Your Omega Reflector

Familiarize yourself with the parts of your telescope and their use.



1. **Optical tube:** Holds and protects the telescope's mirrors.
2. **Primary mirror:** Gathers light from a distant object and focuses an image back to a secondary mirror which redirects the image to the eyepiece lens for magnification.
3. **Dust cap:** Protects the mirrors from scratches and dirt. The dust cap has two parts, a small inside cap and a larger outside cap.
4. **Finder scope:** A low-powered telescope that you align to the main telescope to make it easier to locate distant objects.
5. **Eyepiece:** Brings the image from the telescope's secondary mirror to your eye. Your telescope comes with three eyepieces: one for low power, one for medium power, and a third for high power.
6. **Focuser:** Turn the focusing knob to make images clearer.
7. **Micro-adjustment altitude control rod:** Enables you to make large and small vertical adjustments to the position of the optical tube.
8. **Yoke and altazimuth mount:** Holds your telescope and allows you to adjust your view up and down (altitude) and side-to-side (azimuth).
9. **Tripod:** Supports the telescope and mount. Adjustment knobs allow you to change the height of the tripod and lock it into place for comfortable viewing.
10. **Accessory tray:** Holds your eyepieces, Barlow lens, and image erector for easy access.

3

## Assembly Diagram

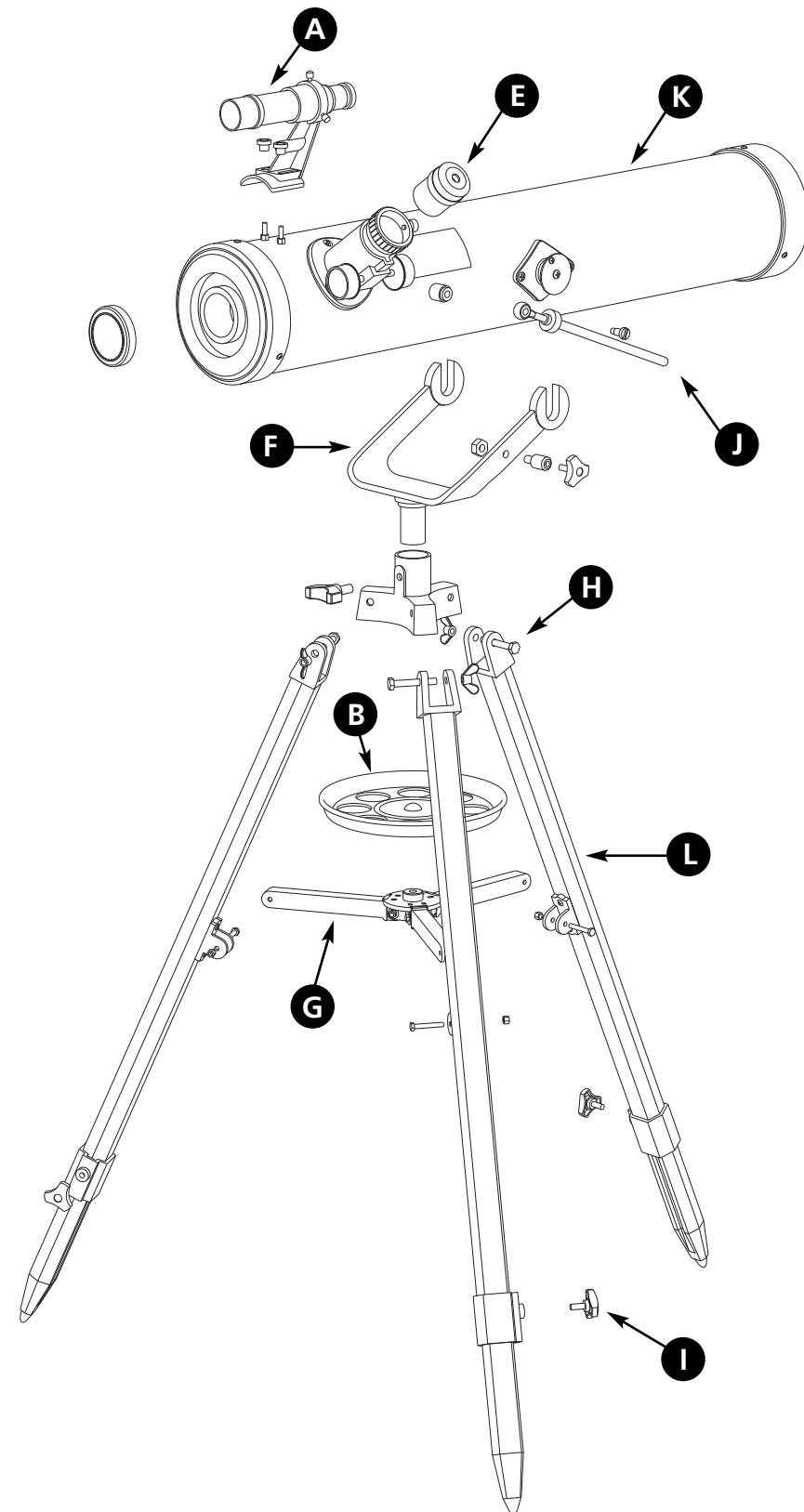

Letters correspond to components list on page 2 and assembly instructions on pages 5-7.

4

## Assembling Your Telescope

Use the picture of your telescope's components on page 2, the Assembly Diagram on the opposite page, and the directions below to assemble your telescope. You will also need a Phillips screwdriver.

1. Extend the tripod legs (L), and lock each one at the desired height with the supplied tripod adjustment knob (I). (See Figure 1.)
2. Connect all three tripod legs to the yoke (F) with the supplied tripod leg attachment bolts, washers, and wing nuts (H). (See Figure 2.) Be sure to fit the bolt into the side of the tripod leg with the hexagonal recess around the hole.
3. Fasten the tripod support bracket (G) to each leg using the included bolts and nuts that come attached to the end of each arm of the tripod support bracket. First, remove each bolt and nut. (See Figure 3.) Then position one arm of the tripod support bracket so that the holes at the end of the arm line up with the hole through the attachment point on the tripod legs. (See Figure 4.) Insert the bolt to attach the tripod support bracket to the tripod leg and tighten the nut. Repeat this procedure with the other two legs.



Figure 1

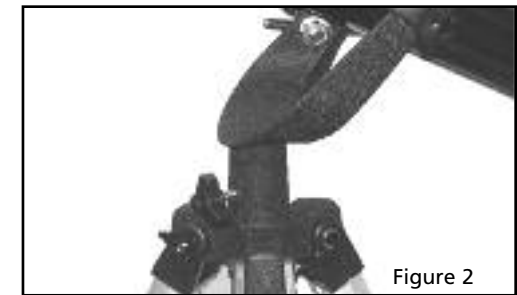

Figure 2

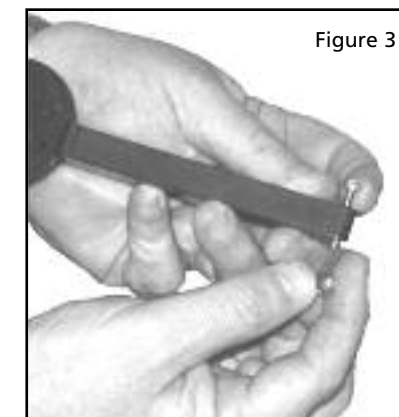

Figure 3

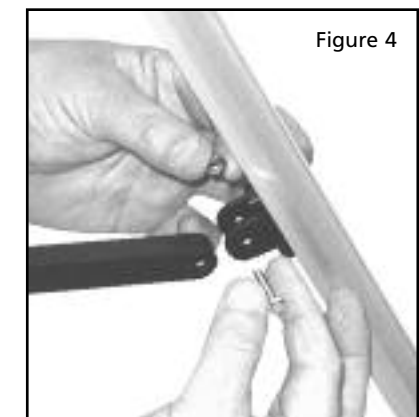

Figure 4

4. Fasten the accessory tray (B) to the tripod support bracket by placing the tray's bolt into the threaded hole and turning the tray clockwise until tight. (See Figure 5.)



Figure 5

5

5. Tighten all nuts and bolts firmly to provide a stable mount for the optical tube assembly (K). On each side of the optical tube there is a round black metal washer. Each washer has a large screw (altitude locking screw) in the center and a smaller screw near the outside edge. Loosen all the screws. Mount the optical tube assembly in the yoke. (See Figure 6.) Rotate each washer slowly while gently tightening the small screw by turning it clockwise with a Phillips (+) screwdriver. When the washer is correctly oriented, the small screw will fit into a hole beneath the washer. Tighten the small screw firmly. Tighten the two altitude locking screws. Repeat this procedure for the other side. (Note: Some production models may have two small screws on each side of the optical tube assembly. In this case, tighten both screws firmly.)



6. Insert the smooth end of the micro-adjustment altitude control rod into the chromed holder located on the side of the yoke. (See Fig. 7). You may have to loosen the large plastic locking knob in order to insert the chromed rod. Once the rod is inserted (with the end with the hole facing the focusing assembly) tighten the large locking knob just enough to prevent the rod from falling out. Locate the chromed post on the side of the telescope tube near the focusing assembly. Remove the screw from the post. Insert it through the hole in the end of the altitude control rod and into the post. Turn the screw clockwise until it is tight.



7. Insert the 20mm eyepiece into eyepiece holder. (See Figure 8.) Tighten the small chrome set screw to hold the eyepiece securely in place.

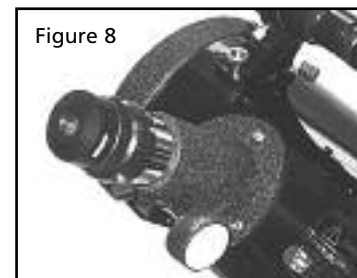

8. Follow the directions on page 7 to install and align your telescope's finder scope **before** using your telescope.

**Note:** Your telescope's primary mirror is a precision ground and polished component that is precisely positioned at one end of the optical tube. It is pre-aligned for maximum performance at the factory and should not need any adjustment. Never adjust or remove any of the screws located at this end of the telescope.



## The Finder Scope

The finder scope is a small telescope that sits on your optical tube. It magnifies objects five times and has a light collecting objective lens that is 24mm in diameter. The viewing field of the finder scope is much wider than that of your telescope so it is easier to locate a particular object with the finder scope. **Always use your finder scope to locate the object you want to view first. The finder scope should be aligned with the main optical tube before you begin using the telescope.** By properly aligning your finder scope with your telescope, it will be easier for you to precisely aim your telescope at objects you want to study.

**Note:** When you look through the finder scope, you will see an upside down and backwards (left/right reversed) image. This is normal for **all** astronomical telescopes.

### Installing Your Finder Scope

1. Your finder scope (A) comes already installed in its mounting bracket. This bracket attaches to your optical tube with the two knurled thumbscrews located near the telescope's focuser. (If the finder scope tube is wrapped in plastic, loosen the three positioning screws on the bracket until you can slide the finder scope out. Remove the plastic and reinsert the finder scope in the same direction that it was positioned before. Tighten the three positioning screws.)
2. Remove the two knurled thumbscrews from the telescope's main tube. (See Figure 9.)
3. Position the finder scope and bracket so that the two slots in the bracket line up with the exposed holes in the optical tube and the larger lens of the finder scope faces in the direction of the open end of your telescope. Replace the knurled thumbscrews and tighten securely. (See Figure 10.) Do not over tighten them as you may crack the bracket.

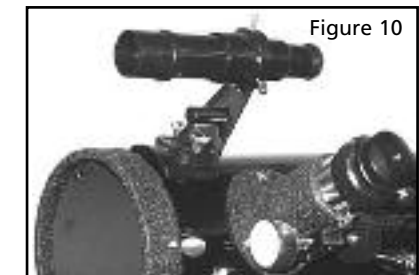
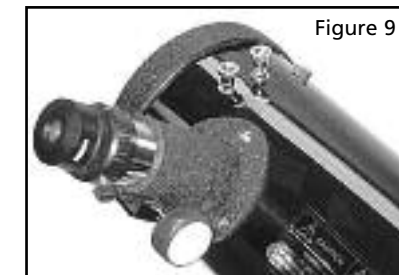

### Aligning Your Finder Scope

To work effectively, your finder scope must be aligned with your telescope. This is most easily done during the daytime with your low power (20mm) eyepiece in place.

1. Remove the dust cap from the front of the telescope. Look through your telescope to locate an easily recognizable object as far away as you can—at least 300 feet away. Loosen the altitude and azimuth controls and the altitude control rod. Turn the optical tube on both its horizontal and vertical axes until the object is in the center of the viewing field. Use the focusing knob to make the image sharp.
2. Tighten the altitude and azimuth lock knobs and the altitude control rod so that the telescope is locked in position.
3. Look through the finder scope. If the object is not visible or centered in the finder scope, release one of the three positioning screws holding the finder scope and carefully reposition the finder scope until the object is centered within the vertical and horizontal lines, called "crosshairs."
4. Occasionally check the view through the telescope to make sure it hasn't moved. When the object is centered in both the finder scope and the telescope, tighten the positioning screws firmly holding the finder scope in place.
5. You may need to repeat this procedure to ensure a perfect alignment. When successfully completed, the finder scope and the telescope will "see" the same view, enabling you to locate and study objects quickly and easily.

## Using Your Telescope

1. For best results, take your telescope outside. Viewing objects through closed or open windows is not recommended. Your view can be distorted by reflections in the glass of a closed window or by air currents of differing temperatures passing through an open window.
2. Let your telescope adjust to the outside temperature. Your telescope will perform much better if the temperature of the mirrors, eyepiece lenses, and the air inside the tube is the same as the outside temperature. In extreme temperatures, it may take up to 30 minutes to acclimate your telescope.
3. It is recommended to start viewing with your lowest power (20mm) eyepiece in place because it gives you the widest angle and brightest, sharpest views.
4. Remove the dust cap. The dust cap consists of two pieces—a small, removable center piece and the large main cap. Both pieces should be removed.
5. Point the open end of the telescope toward the subject you wish to observe. To adjust the telescope horizontally, loosen the azimuth locking knob. To adjust the telescope vertically in large increments, loosen the altitude control locking knob on the altitude control rod. For small vertical adjustments, gradually loosen or tighten the knurled knob on the rod.
6. Move the telescope in the direction of the object you wish to view. Look through the finder scope and pan the telescope until the object appears centered in the finder scope's field of view (the portion of the sky that you can view through a telescope). Once it is in your field of view, tighten the altitude and azimuth control knobs.
7. Look through the eyepiece. If you have properly aligned your finder scope and your telescope, the object will appear in the center of your telescope. Turn the focusing knob until the image is sharp.

### CAUTION:

Never look directly at the sun, with or without your telescope. Never aim your telescope at the sun, or anywhere near the sun. Instant and irreversible eye damage can occur, including blindness.

**Note:** When looking through your telescope, objects will appear upside-down. This is normal for all astronomical telescopes. Your telescope is supplied with an image erector that properly orients images for terrestrial viewing. See page 9 for directions for using your image erector.

## Choosing an Eyepiece for Viewing

Your Omega Reflector comes with three different eyepieces—a 20mm eyepiece, a 12.5mm eyepiece, and a 7mm eyepiece. The eyepieces offer you a range of viewing powers or magnifications. Eyepieces are measured and labeled in “mm” (millimeters). The lowest power (35x) eyepiece is the one with the highest number in millimeters (20mm). The highest power (100x) eyepiece is the one with the lowest number in millimeters (7mm). The 12.5mm is your medium power (approximately 60x) eyepiece.

As a rule, always start with the lowest power eyepiece, gradually switching to the higher powers only after you have located an object. A lower magnification and a wider field of view are recommended for observing galaxies and nebulae. Higher magnification powers should be used for highly detailed observations of the moon, Jupiter, Saturn, or any object that is quite bright.

## Using the Barlow Lens

Your telescope comes with a 3x Barlow lens. This accessory triples the magnification of your eyepieces. When used with the Barlow lens, your 20mm eyepiece will magnify objects approximately 100x, your 12.5 mm eyepiece approximately 180x, and your 7mm eyepiece 300x. In viewing situations where very high magnifying powers are desired, insert the Barlow lens between the eyepiece and the focusing tube. (See Figure 11.)



Figure 11

## Using Your Telescope for Terrestrial Viewing

Your telescope delivers great views of mountains, valleys, and many other features of the world around us. You can also use it to study animals and birds at a distance. To view terrestrial (land) subjects, your telescope comes with an image erector, or erecting eyepiece. This special component orients objects so that you can view them as you would with your naked eye. Follow these directions to use the image erector:

1. Loosen the small screw in the focusing tube and insert the image erector directly into the focusing tube. Tighten the screw to keep the image erector in place.
2. Loosen the small screw in the image erector and insert your chosen eyepiece into the image erector. Tighten the screw to keep this eyepiece in place. (See Figure 12.)

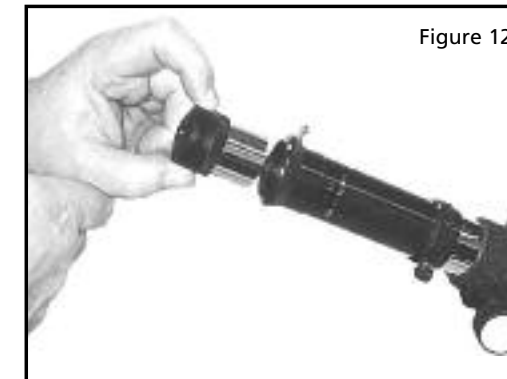

Figure 12

The image erector provides a 1.5x magnification, which means that the 20mm eyepiece will magnify objects approximately 50x, the 12.5mm eyepiece approximately 90x, and the 7mm eyepiece approximately 150x, when used with the image erector.

**Note:** Do not use the 3x Barlow lens with this accessory.

## Tips for Telescope Use

Exploring the night sky with a telescope is exciting—and challenging! Learning to use a telescope takes practice and patience. Here are some tips to better viewing:

1. To locate objects, you must first learn how the sky is laid out. Check books about astronomy to learn your way around the night sky. Then consult one of the web sites on page 12 to check the location of interesting celestial sights. Local astronomy clubs are a good source of information, too.
2. No matter how much light surrounds you, more is always worse. Turn off any lights you can. Also, allow 15 minutes or more for your eyes to adapt to the darkness.
3. Cool your telescope to the outside temperature for about 30 minutes before observing. Cooling the telescope reduces air currents inside the tube that could produce fuzzy, blurry images.
4. Planetary viewing requires good “seeing” conditions—steady, dry atmosphere with little or no clouds. A good way to judge seeing conditions is to check the stars. If the stars appear to be twinkling, a phenomenon caused by a turbulent atmosphere, then conditions are poor for planet gazing.
5. Use slow, steady hand movements when using your telescope. This will minimize vibrations and make it easier to get a steady view.

## Frequently Asked Questions

### 1. Why is the image in my telescope eyepiece upside-down and/or backwards?

If you have inserted your eyepiece directly into the telescope's focusing tube, you will see an image that is upside-down and backwards. This is normal for an astronomical telescope. After all, there's no up or down in space so it doesn't matter how the field is oriented. For terrestrial viewing, when you want images to be oriented properly (as seen with the naked eye), insert the image erector according to the directions on page 9 of this guide.

### 2. Why can't I see anything when I look through my telescope?

If you see only white, gray, or black through the telescope, there are two likely causes. The first is that you have inserted an eyepiece that is too powerful. To solve this problem, switch to a low power eyepiece. As a rule, always start with the lowest power eyepiece (20mm), gradually switching to the higher power eyepieces only after you have located an object. The second cause is that the finder scope is not properly aligned. See page 7 of this guide for the procedure to properly align your finder scope.

### 3. When I use my high power eyepiece, why does everything look darker?

As telescope magnification increases, brightness diminishes. Brightness increases when magnification is reduced. If an image appears dark or unclear, try using your low power eyepiece. It is easier to study small, bright views of celestial objects than large, dark, or blurry ones. You do not need very high powers to study most celestial objects.

### 4. Why do objects in the sky move out of view when I look through my telescope?

When you view a celestial object through a telescope, the rotation of the earth makes it appear as though objects are moving across the viewing area. You can lessen this effect and observe the largest area of the sky by using your low power lens.

## Observing the Night Sky

Your telescope can bring you the moon and stars—and some planets, too.

### Planets

The planets are our solar system companions. They range in size from Pluto, a rocky planet smaller than our moon, to Jupiter, a giant gas ball that could hold 1,000 Earths. Viewing the planets presents some challenges. As the planets in our solar system orbit the sun, their position in our night sky changes. To find out where to look for planets at a particular time, check an astronomy magazine, such as *Sky and Telescope*. You can also visit the magazine's web site, listed on page 12 in this guide.

Most people who have looked up at the night sky have probably seen some planets but did not realize it. A planet, when it is above the horizon, will not twinkle like a star. Planets are resolved by the eye as tiny balls, as opposed to stars, which are infinitely small points of light. The easiest planets to view, when they are visible, are the five "naked-eye" planets: Saturn, Jupiter, Mars, Venus, and Mercury. Mercury is the most difficult to see since it is usually below the horizon.

Each of the planets has its own set of unique characteristics, making them a wonder to behold. Venus is covered with clouds, so all that is visible is an extremely bright light. However, Venus, like the moon, goes through phases that are visible through your telescope. Mars appears to brighten and dim, depending on its distance from Earth. You can observe four of giant Jupiter's many moons and its unusual cloud belt pattern through your telescope when viewing conditions are right. Sighting Saturn's spectacular rings is a rewarding experience for amateur astronomers of all ages.

### Stars

The stars are so far away that when you look at one with your telescope, you won't see a disk as you do when you look at a planet. Even with a large, powerful telescope, a star is seen as a point of light. Some stars look larger than others, but what you are actually seeing is brighter points of light compared to dimmer points of light. The brighter stars aren't necessarily larger, but they appear that way to us. With your telescope, you should be able to see dozens of galaxies, star clusters, and nebulae.

## The Moon

The silvery moon is an exciting subject to view with your telescope. As Earth's nearest neighbor, it's about a quarter million miles away. That may sound like a long distance, but it's close enough that your telescope will reveal a fascinating lunar landscape of craters, plains, and mountain peaks.

Here are a few interesting lunar features to look for:

### Mare Crisium

Mare Crisium ("Sea of Crises") is actually a huge plain formed when great lava flows cooled and hardened on the moon's surface.

### Crater Copernicus

Crater Copernicus is a bright crater with a huge encircling ring of debris that was thrown out of the crater when it was formed by an impacting meteor more than 100 million years ago. It is 60 miles (97 km) across and more than 2 miles (12,600 feet, or 3,840 m) deep.

### Crater Tycho

Bright streaks or rays, best seen during a full moon, emanate from this crater. The rays indicate that this is a young crater. Over time, meteors constantly bombarding the crater's surface will cause the rays to disappear. Crater Tycho is 56 miles (90 km) across and almost 14,000 feet (4,627 m) deep.

### Crater Grimaldi

This large crater looks elliptical in shape, but it is actually circular. It appears to be elliptical because we see it on the western horizon of the moon, which is curving away from us. This effect is called *foreshortening*. Crater Grimaldi is about 140 miles (225 km) across and 10,500 feet (3,200 m) deep.

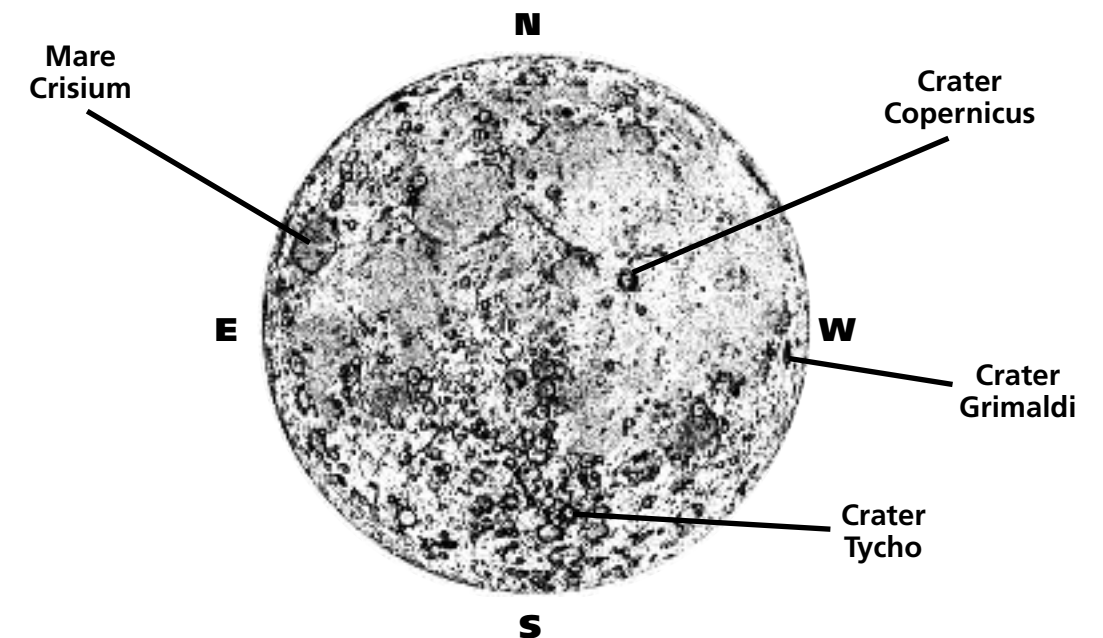

Note: This map, like your telescope, shows a mirror image of the moon.

© Copyright 1982 The Royal Astronomical Society of Canada

## Learn More About Astronomy

Visit these web sites to learn more about astronomy and the objects you see in the night sky:

- <http://www.nasa.gov>  
NASA's official web site
- <http://www.nasa.gov/audience/forkids/home/index.html>  
NASA's link with information for students
- <http://www.nasm.si.edu>  
The web site of the National Air and Space Museum at the Smithsonian Institute
- <http://www.space.com>  
Astronomy web site with interesting links, including a sky calendar listing what's visible in the sky each night
- <http://skyandtelescope.com>  
Astronomy web site with useful information, including a customizable sky chart where you can type in your zip code for a map of the night sky
- <http://cosmobrain.com>  
Astronomy web site with excellent links, including an astronomical calendar listing what's visible in the night sky and an "astrolinks" section to many other outstanding sites

## Caring for Your Telescope

Take good care of your Omega Reflector and it will provide you with many hours of viewing excitement.

### Storage

Your telescope should be stored, fully assembled, in a clean, dry, and dust-free environment. It is unnecessary to separate the optical tube and the mount for storing. If your telescope has to be kept in a basement, garage, or outdoors, cover it with heavy plastic to protect it from moisture, and ensure that the dust cap and lens covers are on. Accessories should be stored separately in a box, with all their dust caps on.

### Optics

Optical components of a telescope will get dirty over time. However, a considerable amount of dirt or dust must be present on the optical surface before you will notice the effect visually. Follow these suggestions to maintain your telescope's optics in the best possible condition:

1. Keep the dust caps on during storage of the telescope to reduce the amount of dust collected.
2. After using the telescope there may be condensation on the optical surfaces. When the telescope is brought inside, remove the dust caps and allow the moisture to evaporate naturally. Point the telescope downwards so as to minimize the collection of airborne dust. Once the moisture has evaporated, replace the dust caps.
3. Filtered, compressed air may be used to remove surface dust from mirror. Remove the dust caps. Once removed, point the can away from the mirror and gently expel some air and any condensation or dust that has accumulated on the discharge tube. Spray the mirror with short bursts of air to carefully remove the dust particles. **Do not hold the trigger of the compressed air can for extended periods because propellant from the can might escape and damage the optical surface.**

If after several attempts, you cannot remove the particles, take the telescope to an optical professional for cleaning. If you keep the dust caps on your telescope when it is not in use and avoid handling the mirrors, only minimal optical maintenance of your telescope should be required. Extensive cleaning is usually only necessary every few years.

**Note:** Your telescope's primary mirror is a precision ground and polished component that is precisely positioned at one end of the optical tube. It is pre-aligned for maximum performance at the factory and should not need any adjustment. Never adjust or remove any of the screws located at this end of the telescope.



## Warranty Information

Dear Customer,

Thank you for purchasing the GeoSafari Omega Reflector Telescope. We're certain that you will enjoy the learning fun offered by this product.

Educational Insights warrants each unit against factory defects in material and workmanship for one year from the date of purchase to the original purchaser only.

This warranty is invalid if the damage or defect is caused by accident, consumer abuse, or unauthorized alteration or repair.

This warranty does not cover any claim concerning worn-out or defective batteries.

If your GeoSafari Omega Reflector Telescope fails to operate satisfactorily during the first year after purchase, return it postage prepaid to the address below. Be sure to include the product, your name, address, phone number and/or e-mail, a copy of your sales receipt or invoice, and a brief description of the problem. If the unit is found to be defective within the first year, it will be repaired or replaced at no further cost to you.

### Direct all returns to:

Educational Insights  
Warranty Replacements  
380 N. Fairway Drive  
Vernon Hills, IL 60061

### Customer Service:

(800) 995-4436 (U.S. & Canada) or  
+44 (0)1553 762276 (U.K. & Europe)

Register your GeoSafari Omega Reflector Telescope at: [www.educationalinsights.com/productregistration](http://www.educationalinsights.com/productregistration)