

Earlex® STEAM CLEANING KIT OPERATING INSTRUCTIONS

MODELS: SC75
SC77
SC125
SC165

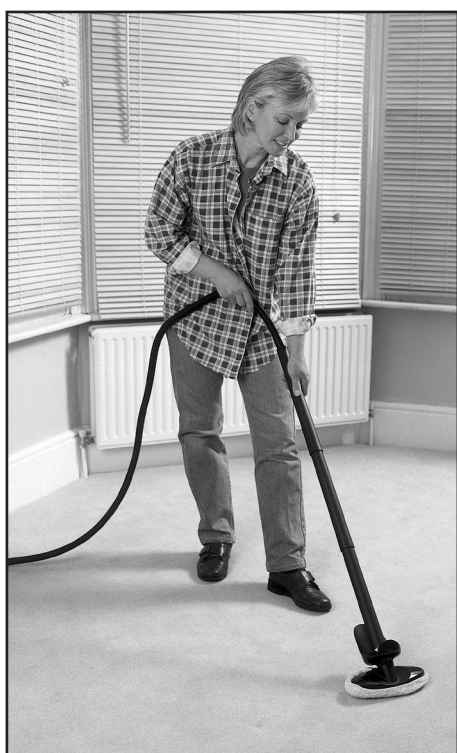

PLEASE READ THESE INSTRUCTIONS CAREFULLY BEFORE USE

Thank you for purchasing an Earlex Steam Cleaning Kit. In order to obtain the best results please read the instructions before commencing any work.
Please also make a special note of the safety rules.

EARLEX LTD. WILL ACCEPT NO RESPONSIBILITY FOR THE USE OF THIS PRODUCT IF USED FOR ANY OTHER PURPOSES THAN THOSE DETAILED HEREIN.

RETAIN FOR FUTURE REFERENCE.

IF YOU HAVE ANY PROBLEMS WITH YOUR STEAM CLEANER OR IF YOU BELIEVE A PART IS MISSING, DO NOT RETURN TO STORE. PLEASE CONTACT EARLEX LTD ON 01483 454666.

SAFETY RULES

- Keep equipment away from children and pets.
- Ensure boiler is placed on a flat level surface, and should the boiler become tilted in use - level again immediately.
Failure to do so can result in severe overheating, complete element failure and void your guarantee.
- Block boiler unit securely if using on stairs.
- Always protect areas beneath the boiler likely to be damaged by heat. The boiler becomes hot in use. Move only by using the carrying handle.
- Steam is produced at 100°C. Be careful, wear protective clothing and protect your hands with heat resistant gloves or mitts.
- Never point hose or steam plate at anyone.
- Always keep steam plate tilted away from face and body, beware of hot drips and regularly empty collected condensation from plate - especially when stripping ceilings and high areas.
- Never remove filler cap or detach hose whilst unit is operating.
- Never block the safety valve.
- Never use outside when raining.
- Switch off and wait for 2 minutes before removing filler cap to refill boiler.
- Do not overfill.
- Allow to cool completely before emptying boiler.
- Do not stand on boiler or hose.
- Do not drag or try to move boiler by pulling with hose or mains lead. If fitted with castors, move with hose only.
- Do not allow water or steam to enter light switches or power points.
- Do not leave unattended.
- Use only standard tap water. Never add detergents or chemicals.
- Do not point the accessories at anyone.
- Extreme care must be taken if the unit is used in bathrooms. Always be aware of danger of electrocution from stored water in baths or sinks.
- Never change tools when the unit is operating.
- Always store upright.
- It is recommended that a RCD (residual current device) rated at 30mA is fitted into the mains supply socket for added protection against electric shock.
- **This appliance is not intended for use by persons (including children) with reduced physical, sensory or mental capabilities, or lack of experience and knowledge, unless they have been given supervision or instruction concerning use of the appliance by a person responsible for their safety'.**
- Use only genuine Earlex replacement parts.
- Warning: hot liquid or steam can burn. Steam may also condense into boiling droplets. Steam should not be directed towards electrical appliances (e.g the inside of an oven).
- The equipment must be unplugged after use and before cleaning.

INTRODUCTION

Thank you for purchasing an Earlex Steam Cleaning Kit. The uses around the home, car and garden are numerous and we hope you will find this product is in constant use to save time, improve the look of your furnishings and to keep everything spotlessly clean.

When cleaning, the Earlex Steam Cleaning Kit will brighten and refresh the colour and restore carpet piles. When decorating, the Earlex Steam Plates (not included in all kits) will remove wallpaper extremely fast and can also be used to remove Artex®, vinyl tiles etc. CAUTION: Some textured finishes may contain asbestos which may be hazardous to health and which are subject to licensing controls operated by the HSE (Health & Safety Executive).

The Earlex Steam Cleaning Kit is also ideal for disinfecting work surfaces, bathrooms, garden soil, etc, since steam will kill house bugs, fleas, insects and many bacteria.

ABOUT YOUR STEAM CLEANER

The Earlex Steam Cleaning Kit will clean most types of surface using the power of steam. The various tools supplied are designed for different applications. With these tools you can select the item most appropriate for the job in hand.

Where towels are supplied dirt will be absorbed by the towel, which is washable and can be replaced as necessary. Packs of replacement towels are available direct from Earlex Ltd.

The Earlex Steam Cleaning Kit does not require detergents, chemicals or other cleaners. It cleans purely by the action of steam. This action also removes any traces of powder or liquid cleaners previously used.

PROTECT YOUR HOME!

The heat generated by the boiler unit can mark carpets, soft furnishings, table tops, cabinets etc.

To prevent this we recommend placing the unit on a wooden board, tray or other barrier - making sure it will not slip off one side or tilt during use.

Dust sheets or newspapers are not suitable heat protectors for delicate surfaces.

IMPORTANT NOTE

Always check the suitability of materials before steam cleaning. Steam is being generated at 100°C. Do not use on any surfaces that cannot stand this temperature e.g. Draylon®, delicate fabrics etc. Always test a small area of the material - preferably a portion that is normally unseen - and allow to dry before starting the full cleaning task.

Do not soak materials being cleaned. Only light application of steam is required.

CAUTION

STEAM IS HOT! Please be aware that steam is produced at 100°C - so be careful, wear protective clothing and protect your hands with heat resistant gloves or mitts.

STEAM CLEANING KIT CONTENTS

Please note: Not all of the accessories shown in this instruction booklet are included in every steam cleaning kit. To check the contents of your steam cleaning kit, please refer to the colour packaging (where supplied), catalogue or store where the unit was purchased. If you are unsure about the contents of your steam cleaning kit, please contact our helpline on 01483 454666.



Component List

Steam Boiler (not shown)	
SC75	D87
SC125	B44
SC165	ST118
Mains Lead with Plug 3m (not shown)	B17
Mains Lead with Plug 2m (not shown)	C3P
a Floor Cleaner	AC254
b Towel for Floor Cleaner	AC275
c Window/Tile Cleaner	AC258
d Jet Nozzle	AC262
e Scraper for Jet Nozzle	AC21
f Brush for Jet Nozzle	AC25
g Universal Handle	AC302
h 3 lengths of Handle	AC01
i 3.6m Steam Hose	ST94
3.6m Steam Hose (SC75)(not shown)	D14

OPTIONAL ACCESSORIES

(Not included in all kits)

j Large Plate for wallpaper stripping	D39
k Small Steam Plate	ST165
l Upholstery Cleaner	AC250
m Towel for Upholstery Cleaner	AC276
Sink Unblocker Tube (not shown)	NRL/.5
Castors (SC165 optional) (not shown)	F17

ASSEMBLING THE ACCESSORIES

The Universal Handle (AC302) is used in conjunction with the Floor Cleaner, Upholstery Cleaner, Window / Tile Cleaner and Jet Nozzle. Align the outline triangle on the handle with the triangle on the accessory. Push the handle into the accessory and twist so that the solid triangles on the handle and accessory are aligned (see Diagram 1).

Over time, you may find that your steam cleaning accessories become awkward to assemble to the universal handle. This is due to the steam reducing the lubrication properties of the 'O' ring seals. In this event, simply lubricate the 'O' ring seals as illustrated (Diagram 2) using washing-up liquid or furniture polish.

The Long Handle Attachment (AC01) is designed to be used when cleaning floors or hard to reach areas. To assemble, pass hose through each of the long handle sections, in at the small end out at the large end. Screw the hose nut onto the universal handle and push the long handle sections together and onto the taper on the universal handle (see Diagram 3). You can use one, two or three sections of the long handle. Disconnect in reverse order. If you have any difficulty in disconnecting twist the handles apart.

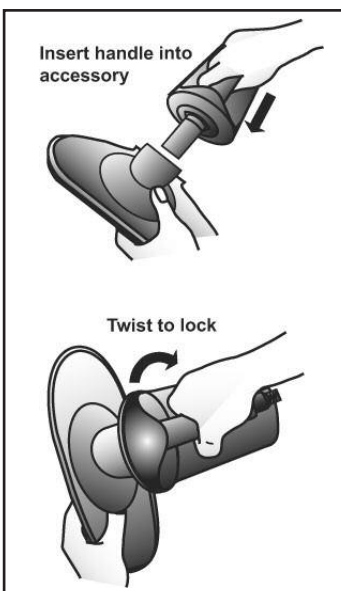

Diagram 1 Assembling Handle

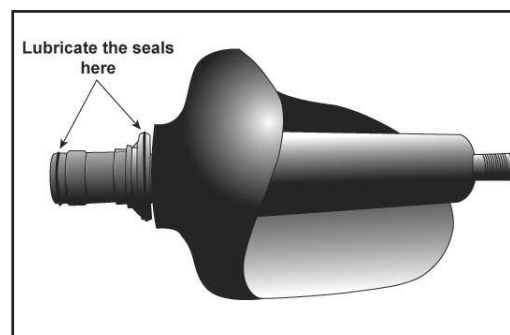

Diagram 2 Seal Lubrication

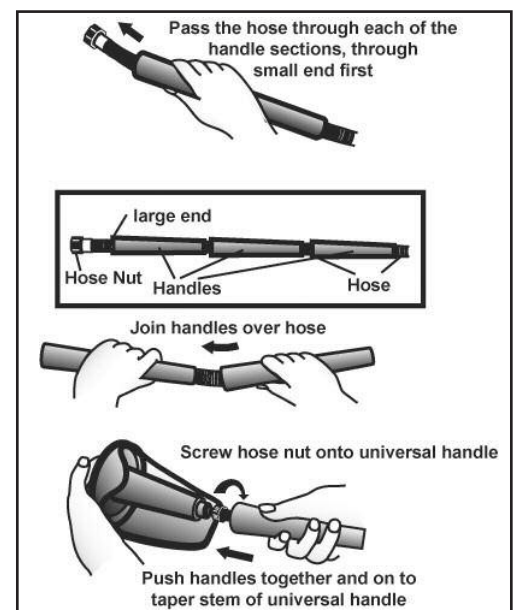

Diagram 3 Fitting Long Handle Attachment

CASTORS (MODEL SC165 OPTIONAL)

The castors are packed separately. Turn the boiler upside down and insert the 3 castors. These should be pushed in hard until they stop. Once installed these remain in place permanently.

FILLING

SC75 (see Fig.1)

Remove elbow filler cap and fill unit to Max. level indicator with clean - preferably hot water.

Ensure that the 'O' ring is seated correctly on the elbow filler cap and place elbow filler cap lugs into filler hole with the tongue pointing to the TWO O'CLOCK position. Turn the elbow filler cap clockwise to the SIX O'CLOCK position so that the tongue locks into place between the two teeth.

SC77, SC125 & SC165 (see Fig.2)

Remove filler cap and fill unit to Max. level line or indicator with clean - preferably hot water.

Replace filler cap.

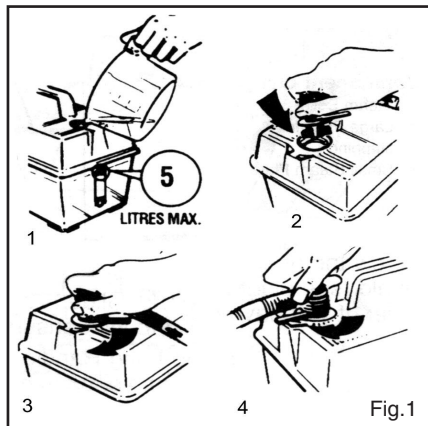

SC75



SC77 SC125, SC165

Do not overfill the unit or hot water will be forced up the steam hose.

Screw hose onto threaded outlets of boiler and accessory, hand tight is sufficient.

Do not over tighten but do check for hand tight fit from time to time during use.

Connect mains lead from unit to power socket and switch on. It can take approx 20 mins before steam is produced - depending on fill water quantity and temperature.

Do not leave unattended and keep children & pets out of the room.

Just before full steam production a small amount of bubbling and water will occur at the accessory. **Beware of hot water discharge prior to steam emission.**

If the unit requires refilling, unplug and allow to cool for at least 2 minutes before removing filler cap - Beware of steam - and re-filling. When finished, allow to cool completely and empty unit. Always store unit empty.

SAFETY CUT- OUT

A safety cut-out is fitted to prevent overheating of the element if water boils below the Min. level.

If unit stops boiling during use this may be the cause. Wait for 2 minutes before removing filler cap then re-fill with water. The cut-out will self reset and steam be produced again within 20 minutes.

The cut-out will not protect the element if a part filled unit is tilted during use in a way which enables part of the element to be out of the water for longer than 15-20 seconds.

CHANGING TOOLS

Never remove the hose or change tools when the unit is plugged in. Wait 2 minutes after unplugging before changing tools. Screw the nut, which is on the end of the steam hose, onto the outlet of the tool - **hand tight only.**

FLOOR CLEANER

IMPORTANT

Some carpets have stain resistant treatments, which have varying active lives before breakdown. Accordingly it is best to try a small area of carpet that is normally unseen, then allow 24 hours to check whether the steam has any unusual effects on the carpet material, e.g. white streaks. If this happens DO NOT CONTINUE USE - Check with your carpet supplier for further advice.

Used correctly the floor cleaner will refresh your carpet by removing surface grime, pet hairs etc. leaving the carpet looking brighter.

It is not a dirt extraction system, so cannot necessarily remove deep stains or grease. Attempting to make it do this by longer action of steam may result in watermarking or staining.



Cleaning carpets

Connect the universal handle and long handle to the floor cleaner head. Fit the cleaning towel to the head by placing the towel over the floor cleaner head and pulling the drawstring tight. The drawstring can be secured at the back of the floor cleaner. (See diagrams to right) Before using the floor cleaner, use a vacuum to pick up the larger dirt and grit particles. Having prepared the area, plug the boiler unit in and wait for steam to appear at the accessory head. **Beware of hot water discharge prior to steam emission.** Now begin to move the floor cleaner head over the carpet at a steady pace. If there are stains on the carpet pause for a few seconds to allow the steam time to penetrate.

Do not soak the carpet. Glide the floor cleaner over the surface. It is generally better, and easier, to pull rather than push the head across heavy pile carpets. Do not try to scrub the surface.

The towel will collect the dirt. Both sides of the towel can be used. Used towels can be washed out and reused. Wash at 90°C for maximum longevity. Do not use bleach or fabric conditioner. Use only one third of normal soap powder to avoid clogging of the fibres.

Spare towels can be purchased from Earlex.

The Floor Cleaner can also be used on other types of flooring such as ceramic, cork, marble, linoleum, stone, parquet etc. If you have an area to clean which has joints (such as tiles) it may be useful to use the brush attachment of the jet nozzle in order to clean completely. Be especially careful with parquet - older oak floors are very tough but on some newer floors steam may cause the blocks to swell. Always take advice from the manufacturer of the floor covering before proceeding to use steam. One useful point to note is that steam will cause animal hairs to roll into easily removable balls. This attachment can be used on car interiors, motor homes, painted doors, walls, louvres etc.

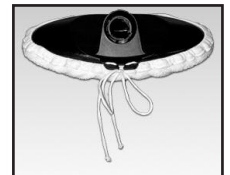
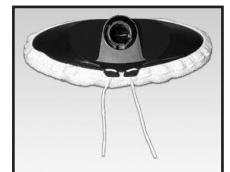
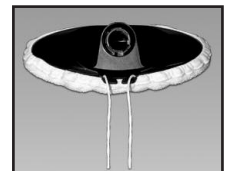

WINDOW/TILE CLEANER

IMPORTANT - You should only proceed at your own risk.

When cleaning exterior glass be extra careful not to pick-up any grit on the rubber blade - which could cause scratches.

Antique glass and stained glass may be brittle and can crack under extreme temperatures.

Do not use on glass at temperatures below 0°C.

Connect the universal handle and long handle to the window/tile cleaner head. Select the length of handle required (if any).

Plug the boiler unit in and wait for steam to appear at the accessory head. **Beware of hot water discharge prior to steam emission.** Steam will be emitted from the apertures on the accessory head. Move down the windows and clean with the rubber blade as the accessory travels down the surface. Always pull the accessory towards the handle so that the blade is acting after the steam. Do not push the accessory away from the handle. After you have completely finished cleaning, switch off the unit and clean the glass or tiles from top to bottom with the rubber blade only.

Steam will completely remove dust, film or greasy marks from windows, mirrors and patio doors. The window/tile cleaner will remove soap and grease residues but cannot remove deposits of scale. To remove black marks from grouting or corners use the jet nozzle with brush or scraper attachment.



Window cleaning with long handle



Cleaning tiles

JET NOZZLE

Connect the universal handle to the jet nozzle head. Select the scraper head or brush to fit the nozzle end if required and push on to the nozzle.

Plug the boiler unit in and wait for steam to appear at the accessory head. **Beware of hot water discharge prior to steam emission.** This accessory can be used for cleaning all round the house, stoves, cupboards, work surfaces, toilets, sinks, lawnmowers etc. It both cleans and disinfects at the same time. It can also be used to defrost your freezer in minutes with no inconvenience. **Check with fridge/freezer manufacturer for advice before use.**



Cleans lawnmowers,
use with scraper



Defrosts freezers

SINK UNBLOCKER TUBE (OPTIONAL ACCESSORY - NOT INCLUDED IN ALL KITS)

Connect the universal handle to the jet nozzle head and push one end of the sink unblocker tube into the hole in the end of the jet nozzle.

Thread the sink unblocker tube through the strainer in the plug hole to be unblocked. Plug the boiler unit in and once steaming, further insert the sink unblocker tube towards the blockage.

If whilst using the sink unblocker, you see steam escaping from the safety valve on the boiler unit, you may have blocked the tube by pushing it too hard into a blockage.

DO NOT FORCE SAFETY VALVE SHUT - switch off the boiler unit, remove the sink unblocker tube and clean with a small screwdriver, stiff wire or knitting needle.

Once steam is coming out under the surface of the water you will hear a rattle as the steam causes considerable vibration. The combination of heat and vibration will loosen and dissolve the blockage. Once the blockage starts to clear, water should be run through while the sink unblocker is still operating to flush out the blockage.



UPHOLSTERY CLEANER (OPTIONAL ACCESSORY - NOT INCLUDED IN ALL KITS)

IMPORTANT

Some upholstery, fabrics or soft furnishings have stain resistant treatments, which have varying active lives before breakdown. Accordingly it is best to try a small area that is normally unseen, then allow 24 hours to check whether the steam has any unusual effects on the fabric material. If so, **DO NOT CONTINUE.** Check with your fabric or furnishing supplier for further advice.

Do not allow the material to become soaked. You only require a small amount of steam to clean, and soaking can leave water marks or cause bleed through from linings etc.

Connect the universal handle to the upholstery cleaner head. Fit the cleaning towel to the head in the same way as the Floor Cleaner (see page 5). Spare towels can be purchased from Earlex. Used towels can be washed out and reused. Wash at 90°C for maximum longevity. Do not use bleach or fabric conditioner. Use only one third of normal soap powder to avoid clogging of the fibres.

Curtains & Clothing

The upholstery cleaner head can also be used for removing the creases from hanging curtains and to clean and remove creases from overcoats, suits, jackets, trousers, etc.



LARGE STEAM PLATE - WALLPAPER STRIPPING (OPTIONAL ACCESSORY - NOT INCLUDED IN ALL KITS)

CAUTION! Check the state of your plaster before starting work. Steam can loosen weak, porous or poorly bonded plaster - which also loosens readily if cracked, holed or if the steam plate is held in place too long after the paper is soaked. Weak plaster can normally be detected by tapping a few areas of wall. A hollow sound indicates that you should proceed only with extreme care - stopping immediately if you hear a cracking sound or plaster starts to break loose. The steam stripper is safe for drywall/plaster board surfaces but whatever the material, it is always wise to check a small area before starting work properly. Always obtain advice from an expert if unsure.

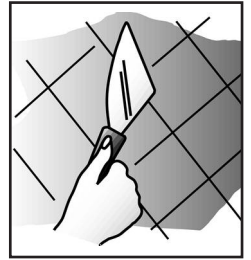

PREPARATION

To achieve fastest paper removal always gently score the areas to be stripped. With heavy embossed, vinyl coated or painted papers this is essential. Either use a proprietary perforator tool or alternatively score the paper with the edge of a wall scraper in a criss-cross pattern with 150mm (6 inch) spacing.

As with all decorating work be sure to protect carpets and furniture with covers.

STRIPPING: Remember to check a small area first.

Connect the large steam plate to the steam hose. Once steam is being produced at the hand plate you are ready to begin. Operation is simple for both right and left handed people. Simply hold the steam plate flat against the wallpaper for approx. 10 seconds. Now move the plate to the spot immediately next to the one just steamed - from which the paper should now easily come away with a little help from a wall scraper.

Working this way should enable continuous paper removal although it may be necessary to steam for longer periods with some papers, or if not completely removed first time.



SMALL STEAM PLATE (OPTIONAL ACCESSORY - NOT INCLUDED IN ALL KITS)

The small steamplate is used in the same way as the large steam plate to strip wallpaper in awkward areas not easily reached with the large steam plate such as around door frames, in corners, etc.

Always wear a glove or mitt for added protection.



OTHER USES FOR THE STEAM PLATE

Artex®: Normally Artex® can be removed using the same method as for wallpaper although the steaming time will be longer. **CAUTION:** Some textured finishes may contain asbestos which may be hazardous to health and which are subject to licensing controls operated by the HSE (Health & Safety Executive).

Vinyl Floor Tiles: Vinyl floor tiles can also be removed if the plate is left long enough for the heat to penetrate the adhesive. Once the adhesive is hot it softens and the tile can be peeled from the floor.

Sterilising Soil: To sterilise soil in seed trays or greenhouses rake the soil to obtain a fine surface. Leave the steam plate on each section for 2 to 2.5 minutes which should ensure that the steam has penetrated through the surface.

Killing Weeds: Steam will kill weeds on paths and patios without the use of chemicals. You will need to steam the weeds for 1 to 1.5 minutes in order to kill them.

MAINTENANCE

To keep the unit and tools clean, wipe over with a clean, damp cloth. No other maintenance work should be required. See the Trouble Shooting Guide if you experience any problems.

DESCALING

To maintain peak performance of the unit, particularly in areas of hard water, it may be necessary to descale the element in the unit. Proprietary kettle descaling products can be used in your Steam Cleaning Kit - always follow the manufacturer's instructions.

TROUBLE SHOOTING
IF A PROBLEM OCCURS ALWAYS SWITCH THE UNIT OFF IMMEDIATELY.

PROBLEM	CAUSE	ACTION
Unit fails to boil.	Safety cut-out has operated. Fuse has blown in lead. Power cord extension being used. Element burnt out due to tilting of unit in use or a chemical used in boiler.	Refill boiler making sure to cover the element; allow unit to cool for 20 mins then re-try. Replace with a 13 amp fuse only. Extension cables must be rated at at least 10 amps and fully unwound. A lower rating will trip out. The element cannot be replaced, you can buy a replacement boiler from our Service Department.
Unit leaks from Pressure Relief valve.	Dirty seal. Blockage/kink in hose. Blockage in inlet of tool.	Unplug the unit and allow to cool. Clean seal and surface it sits on. Allow unit to cool then remove hose and check for blockages. When unit is cool check for obstruction in inlet.

IF YOU REQUIRE FURTHER ASSISTANCE PLEASE CONTACT OUR HELPLINE ON
Tel: 01483 454666 Fax: 01483 454548 email: enquiries@earlex.co.uk
Opening Hours: Monday - Friday 08:30 - 17:30 (Except Bank Holidays)

MAINS CONNECTION

Your unit has been supplied with a mains lead with a fitted plug. This is identified by the fuse holder in the base of the plug. Please read the following safety instructions before use.

1 If the fitted plug is cut off from the mains lead then the plug must be disposed of safely. **NEVER** under any circumstances insert such a plug into a 13 amp socket.

2 **NEVER** under any circumstances use the appliance or mains lead without the fuse cover fitted. This is the little cover fixed into the base of plug to hold the fuse in place.

3 If you lose the fuse cover then please contact any electrical dealer for a replacement or ring our helpline.

4 A replacement fuse must be rated at 13 amp. These must be manufactured and approved to BS 1362.

5 **IF IN ANY DOUBT PLEASE CONSULT AN ELECTRICIAN.**

If you need to fit a plug to the mains lead, this should be fitted in accordance with the wiring instructions below, and will need to be used with a 13 amp fuse. If in any doubt consult an electrician.

WARNING - THIS APPLIANCE MUST BE EARTHED. If you are using an extension lead it must be rated at a minimum of 10 amps and fully unwound. Do not operate with a lead rated at less than 10 amps as this will cause premature failure of the element which is not covered by the guarantee.

As the colours of the wires in the mains lead of this appliance may not correspond with the coloured markings identifying the terminals in your plug, proceed as follows:

The wire which is coloured green and yellow must be connected to the terminal in the plug which is marked with the letter E or by the earth symbol, or coloured green or green and yellow.

The wire which is coloured blue must be connected to the terminal which is marked with the letter N or coloured black.

The wire which is coloured brown must be connected to the terminal which is marked with the letter L or coloured red.

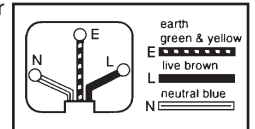

INFORMATION ON THE DISPOSAL OF WASTE ELECTRICAL EQUIPMENT KNOWN AS WEEE

Your attention is brought to new directives applicable to the disposal of this electrical equipment, where in accordance with the legislation this product must not be disposed of in your normal household waste. Instead it is your responsibility to dispose of this type of waste by handing it over to special designated collection points for recovery and recycling. This product is marked with a 'Wheelite bin' symbol with a cross on it to remind you of this action. The objective of this directive is to help conserve resources and ensure that it is recycled in a manner that protects human health and the environment. For more information about where you can drop off your waste please contact your local authority, take back facilities are free of charge.



GUARANTEE

This product is guaranteed for a period of 24 months against faulty materials and workmanship. Whilst every possible care is taken by Earlex to ensure that our products leave the factory in good working order, Earlex cannot under any circumstances accept liability for problems or damage caused by their subsequent use. It is the responsibility of the user to ensure that surfaces to be treated, cleaned or stripped are suitable for steam. This guarantee does not effect your statutory rights. This guarantee excludes the use for hire purposes. In the event of a fault occurring please contact our helpline before returning the unit to our Service Department at the address below together with a copy of your purchase receipt. All repairs will be dealt with speedily.

EC Declaration of Conformity
We declare that the units: SC75, SC76, SC77, SC125, & SC165 conform to: 2006/95/EC EN60335-1, **EN60335-2-54** & 89/336/EEC, EN55014-1, EN 55014-2, EN 61000-3-2, EN61000-3-3, EMF EN 50366

Tim Hopper - Technical Director

Patents: GB 2294515, GB 2300698, GB 2, 253, 685, GB 2 422 731, PCT/ GB06/ 001222 DE 20 2006 007 103.2, DE 19539236.1, DE 29522026, DE 690 04 269,

FR 2726068, FR 06/ 03977, US 5, 762,108

Design Registration Nos: GB 2046683, GB3004739, DE 40205274.9, FR 02 4020, GB 2046682, GB 1059125, US D496, 504S



Earlex Ltd. Moorfield Road, Guildford, Surrey. GU1 1SZ.
Tel: +44 (0) 1483 454666. Fax: +44 (0) 1483 454548. email: enquiries@earlex.co.uk Website: www.earlex.co.uk

© 2007 Earlex Ltd.

AC309 05/07